



Patent 20040600

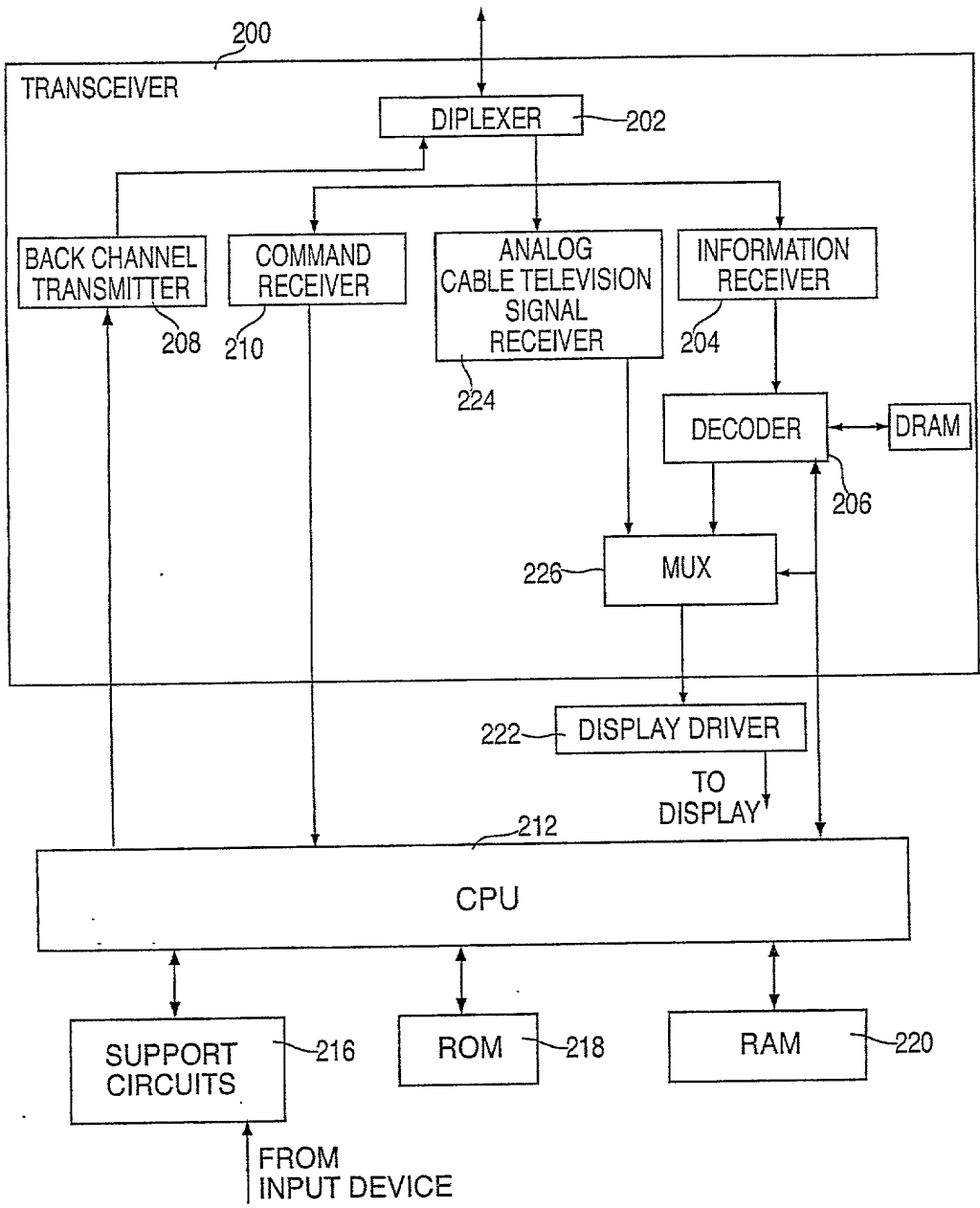
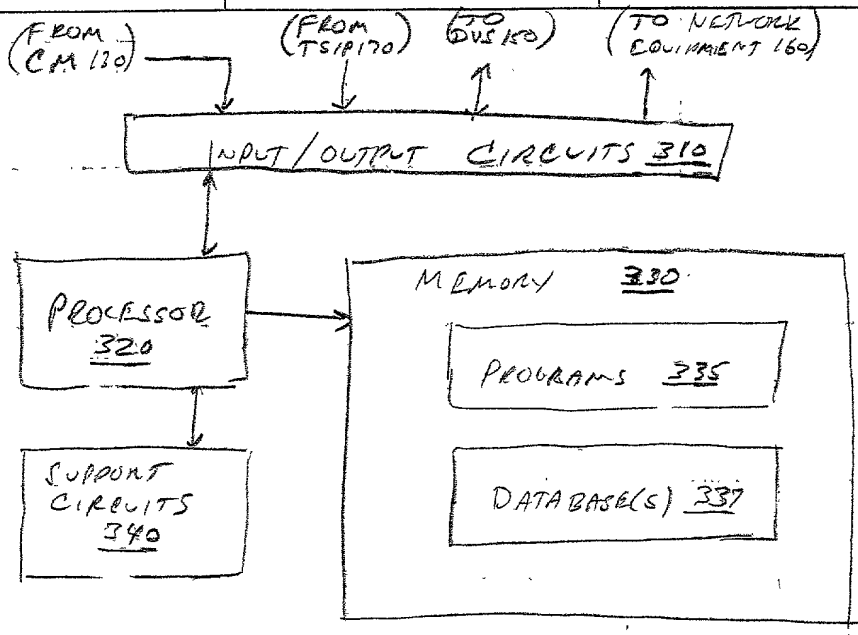

FIG. 2



300

FIG. 3

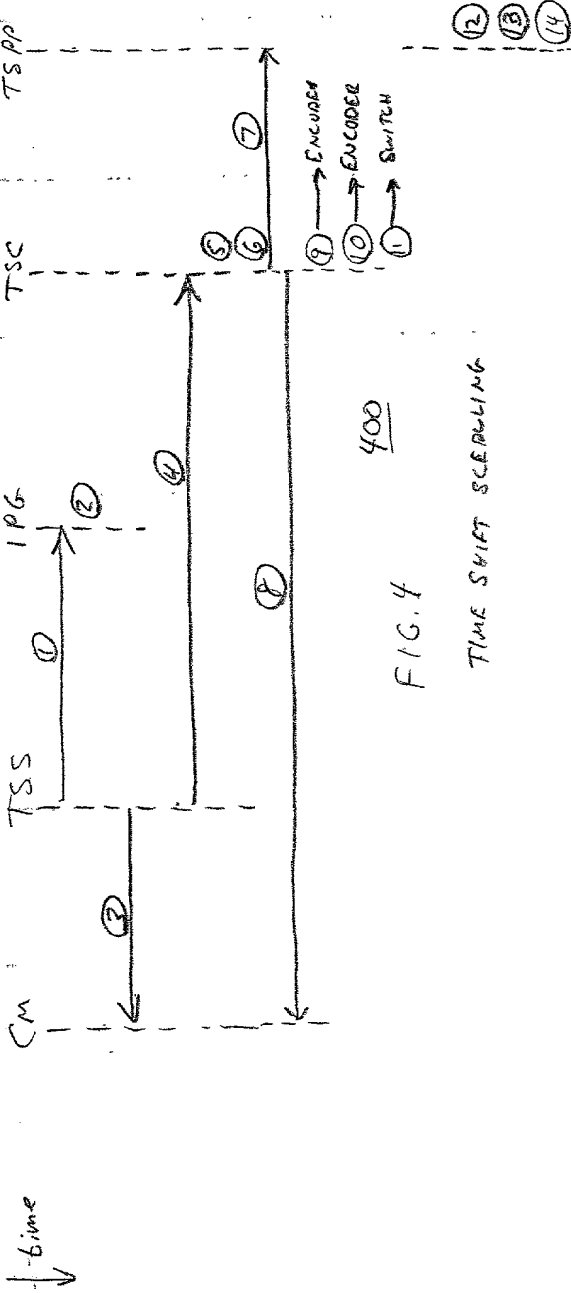
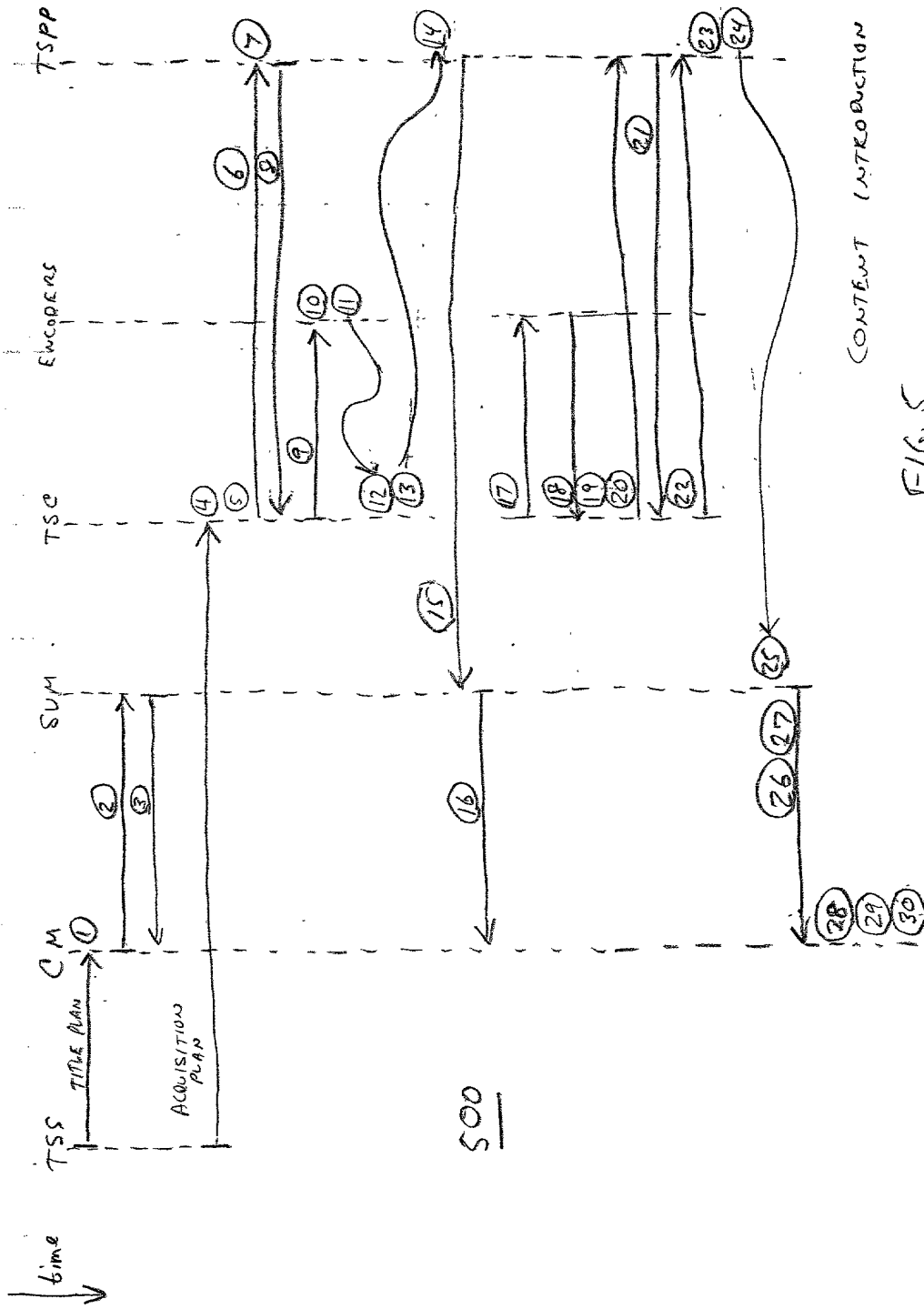

FIG. 4

TIME SHIFT SCHEDULING



CONTENT INTRODUCTION

FIG. 5

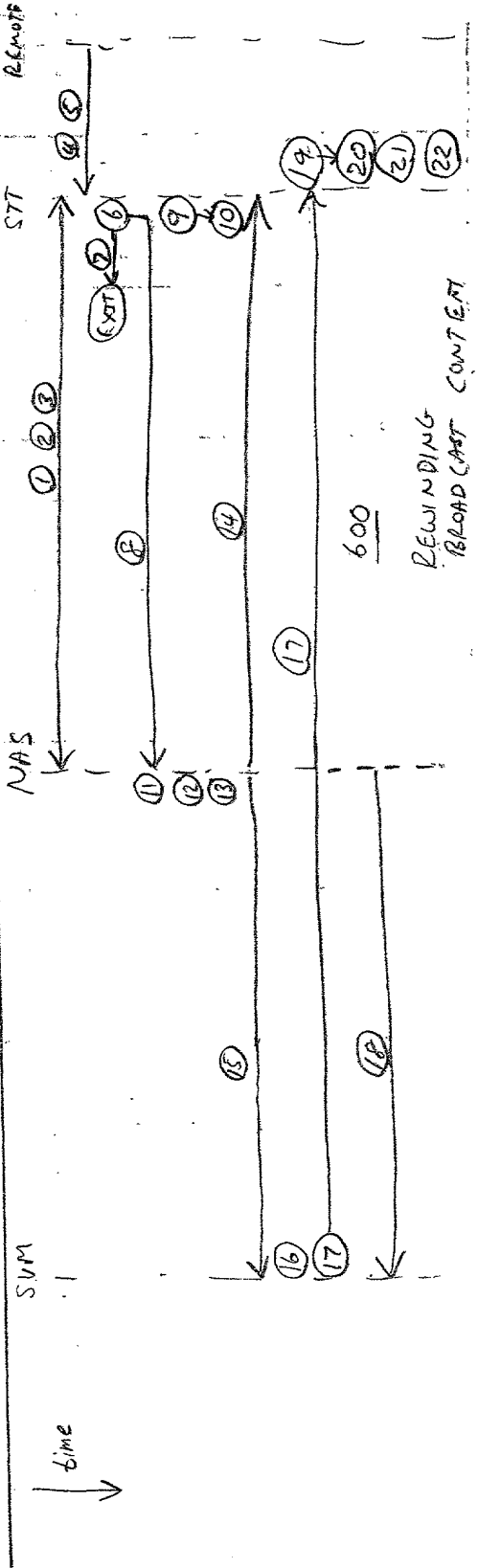
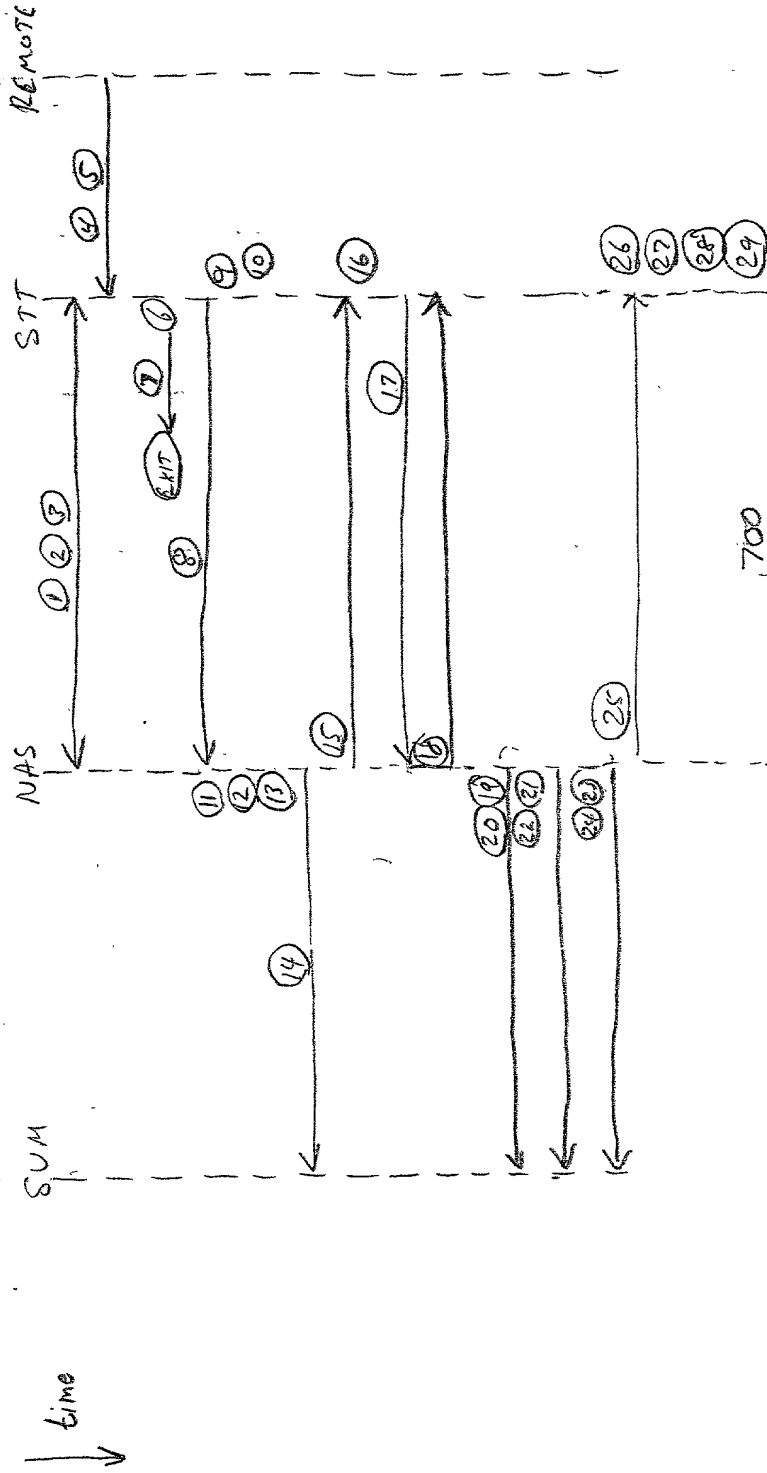
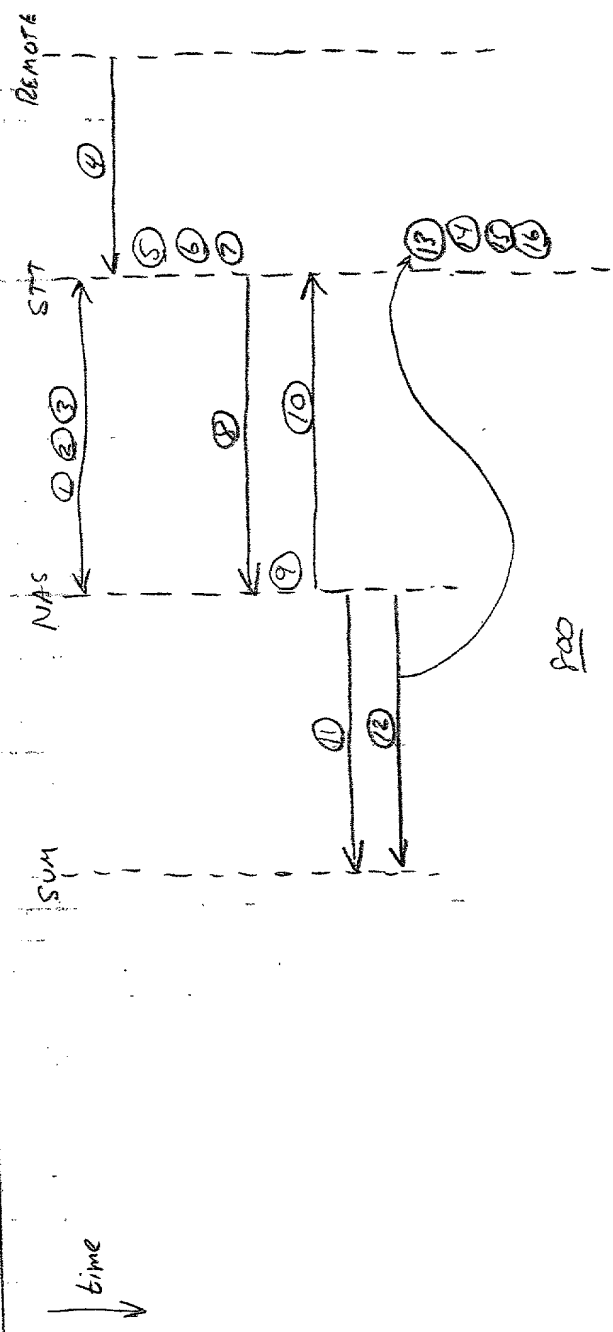

FIG 6



USING BROADCAST CONTENT  
 FIG. 7



INITIATING DIA-TV SERVICE VIA IRG

FIG. 8



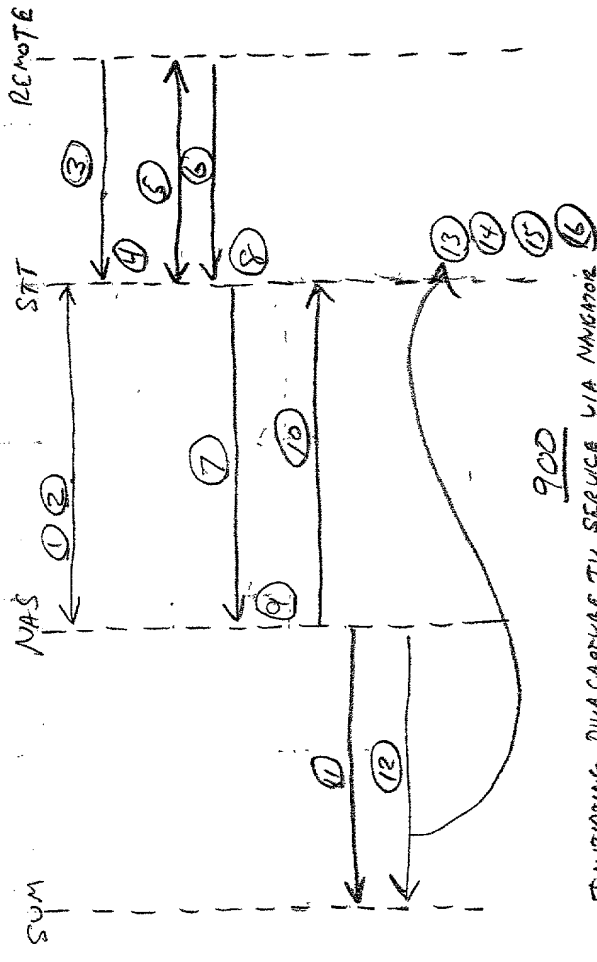

INITIATING DIVA CAPTURE TV SERVICE VIA NAVIGATOR

FIG 9

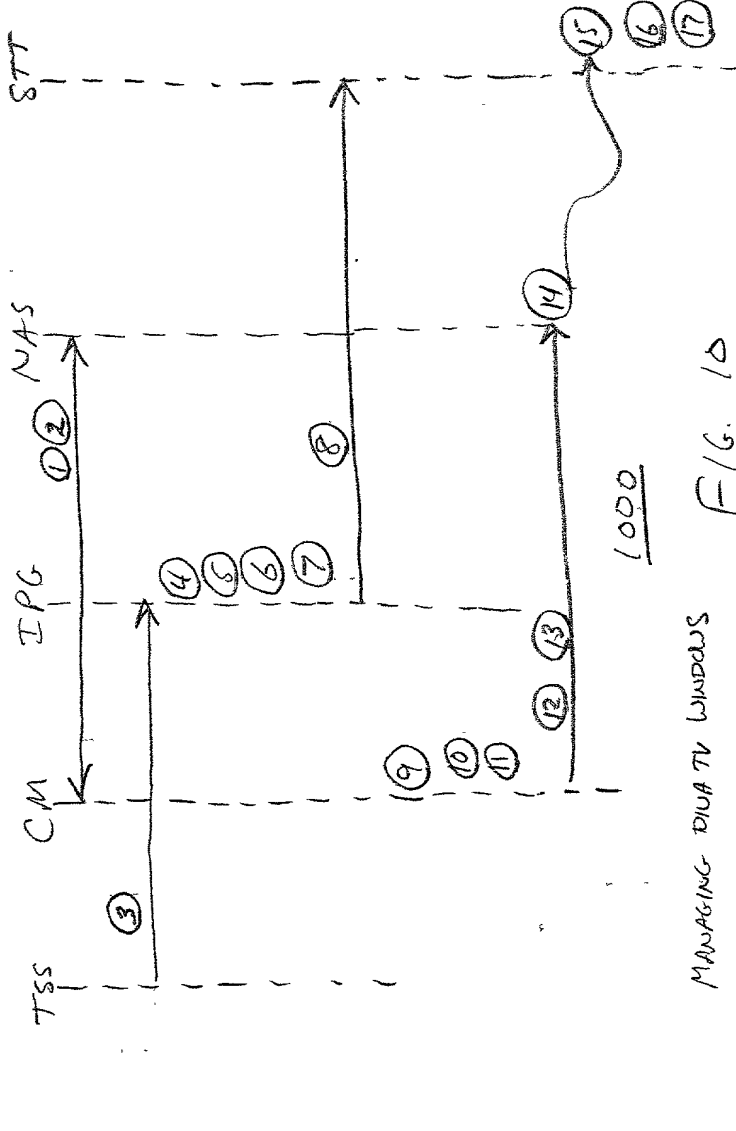

MANAGING DIA TV WINDOWS

FIG. 10